

High-speed, 1-needle,
Unison-feed, Lockstitch Machine
with Large Hook and
Automatic Thread Trimmer

LU-2210N-7

(1.6 fold-capacity hook)

LU-2210W-7

(double-capacity hook)

High-speed, 2-needle,
Unison-feed, Lockstitch Machine
with Large Hooks and
Automatic Thread Trimmer

LU-2260N-7

(1.6 fold-capacity hook)

LU-2260W-7

(double-capacity hook)



LU-2210N-7

* Operation panel is optionally available.



LU-2260N-7

* Operation panel is optionally available.

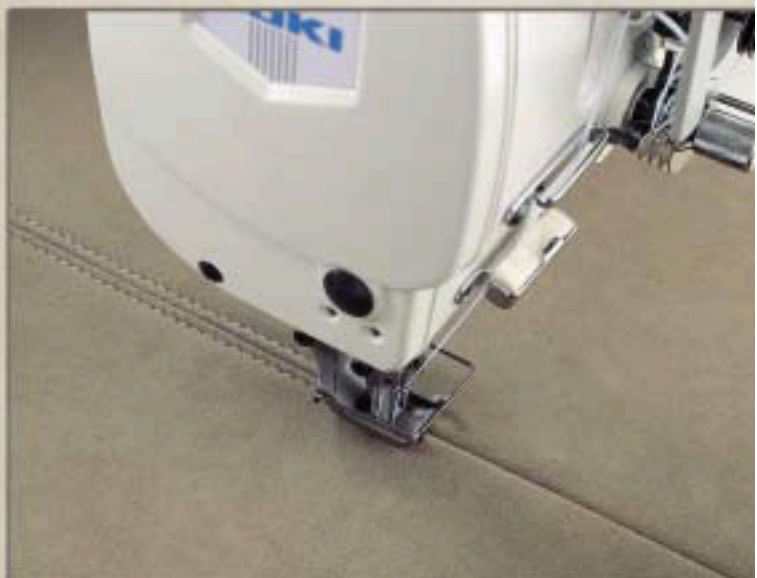

LU-2260N-7

Excellent responsiveness when sewing heavy materials such as car seats and sofas.



LU-2210N-7
* Operation panel is optionally available.



LU-2260N-7
* Operation panel is optionally available.

Consistent sewing performance at a high speed

Thanks to its remarkable feed efficiency and improved feed cam unit, the machine smoothly feeds materials at high speeds while preventing stitch gathering. The machine is also equipped with a new box-type feed locus that enables the production of beautifully finished seams free from material flopping.



LU-2260N-7

Thread trimming without fail

The rigid movement of the knife-driving shaft and ideal shape of the cam enable the thread trimmer to trim thread as thick as #5. Further-more, no adjustment is necessary after changing the thread count.



LU-2260N-7

The walking foot and presser foot's alternating vertical movement can be set and changed with ease

The vertical strokes of the presser foot and walking foot (their alternating vertical movement) can be easily changed using a large dial mounted on the top surface of the machine head. In addition, the sewing speed is automatically adjusted with the set value. With this feature, ideal sewing conditions are maintained at all times.



LU-2210N-7

Sufficiently large presser foot lift

The machine is equipped as standard with a pneumatic auto-lifter. The lift of the presser foot is 16mm, allowing the operator to handle the material under the presser foot with ease. The auto-lifter is controlled by a light-to-the-touch pedal, thereby helping reduce operator fatigue.



The instant changeover of the walking foot and presser foot's alternating vertical movement is especially effective when sewing over-lapped sections of materials

A function to instantaneously change over the alternating vertical movement of the walking foot and presser foot (DL) is provided as standard with the machine. With this function, the alternating vertical movement of the walking foot and presser foot can be changed over to the maximum value simply by turning on the switch.













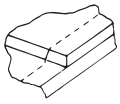



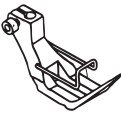
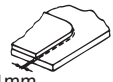

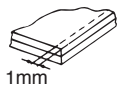

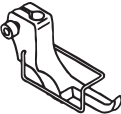
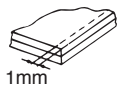
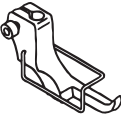
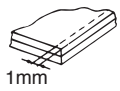

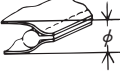
Push-button type

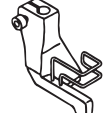
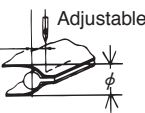
Knee-switch type

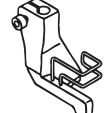
INTERCHANGEABLE GAUGE PARTS

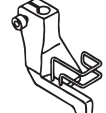

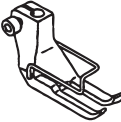

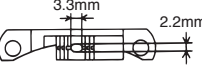
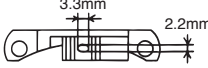
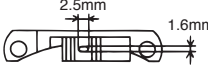
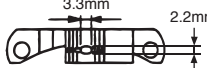
● LU-2210N-7, LU-2210W-7

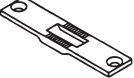
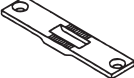
Sewing conditions		Walking foot		Presser foot			
Standard 		A	Standard		A	Standard	
		107-11653			107-12552		
For material with overlapped section Allows the smooth feed of multi-layered portions of the material 					K	Standard (pressing face is reduced)	
					107-58456		
For light-weight sponge Used for resilient materials including sponge 					B	For material with overlapped section	
					107-12651		
For heavy-weight sponge Used for more resilient materials Thick 					C	For urethane	
					107-12750		
Right single-sided presser Used for sewing material edges  1mm					B	For urethane	
					107-11752		
Left single-sided presser Used for sewing material edges  1mm					C	Right single-sided presser	
					107-11851		
Right single-sided presser Used for sewing material edges  1mm					D	Right single-sided presser	
					107-12859		
Left single-sided presser Used for sewing material edges  1mm					E	Left single-sided presser	
					107-11950		
For piping Used for the general piping process 					E~H	For piping	
					ϕ 3 107-45354 ϕ 4 107-45453 ϕ 5 107-45552 ϕ 6 107-45651		
For piping The position of the needle can be adjusted according to the pipe to be sewn 					F~J	For piping	
					ϕ 3 107-47350 ϕ 4 107-47459 ϕ 5 107-47558 ϕ 6 107-47657		
Wide type To be used when a sewing product cannot be smoothly fed 					J~M	Adjustable presser for piping	
					ϕ 3 107-46352 ϕ 4 107-46451 ϕ 5 107-46550 ϕ 6 107-46659		
Wide type To be used when a sewing product cannot be smoothly fed 					(special order)	(special order)	
					107-12057		

Feed dog			
			
107-17106	107-17205	107-17304	107-39001
S	Standard	A	Without groove Used when the needle thread does not interlace consisting with the bobbin thread at the start of sewing.
		B	For thin thread
			Wide type (special order)

Throat plate	
	
107-01704	107-02009
Standard	Wide type (special order)

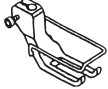
● LU-2260N-7, LU-2260W-7

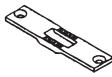
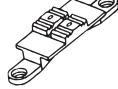
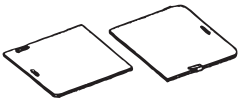
Needle gauge	Typical* part Nos.	Needle clamp	Presser foot	Walking foot	Needle plate	Feed dog	Slide plate	
							Left	Right
								
4mm (Special order)	107-84551	107-77555	107-81557	107-83058	107-84502	107-80005	107-86309	107-01803
6mm	107-84650	107-77654	107-81656	107-83157	107-84601	107-80104		
8mm	107-84759	107-77753	107-81755	107-83256	107-84700	107-80203		
10mm (Standard)	107-84858	107-77852	107-81755	107-83355	107-84809	107-80302	107-86408	107-86002
12mm	107-84957	107-77951	107-80401	107-83454	107-84908	107-80401		
14mm (Special order)	107-85053	107-78058	107-82050	107-83553	107-85004	107-80500		
16mm (Special order)	107-85152	107-78157	107-82159	107-83652	107-85103	107-80609		
18mm (Special order)	107-85251	107-78256	107-82258	107-83751	107-85202	107-80708	107-86507	107-86101
20mm	107-85350	107-78355	107-82357	107-83850	107-85301	107-80807		
22mm (Special order)	107-85459	107-78454	107-82456	107-83959	107-85400	107-80906		
24mm (Special order)	107-85558	107-78553	107-82555	107-84056	107-85509	107-81003		
30mm (Special order)	107-85657	107-78652	107-82654	107-84155	107-85608	107-81102		
36mm (Special order)	107-85756	107-78751	107-82753	107-84254	107-85707	107-81201	107-86606	107-86200

* The right and left slide plates are not included in the parts represented by the typical part numbers.

WHEN YOU PLACE ORDERS

Please note when placing orders, that the model name should be written as follows:

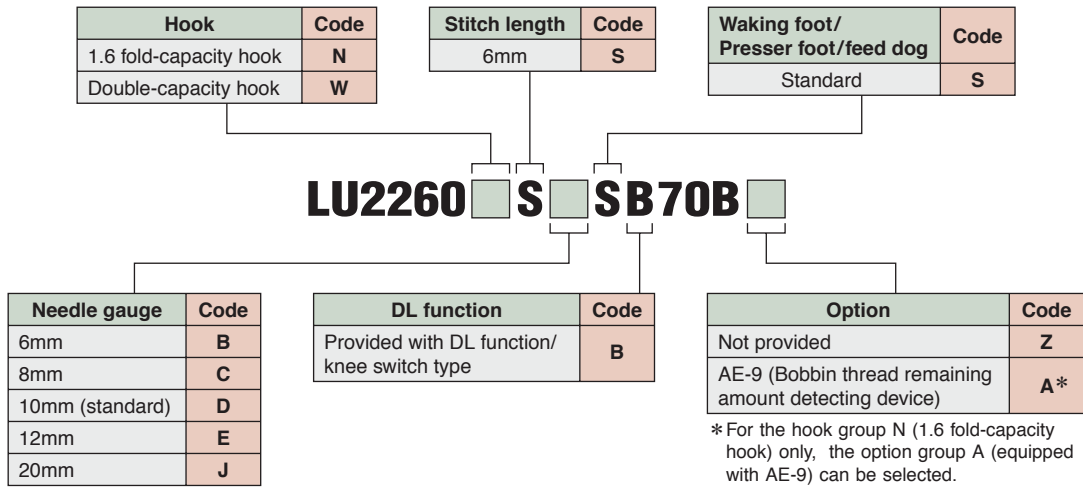
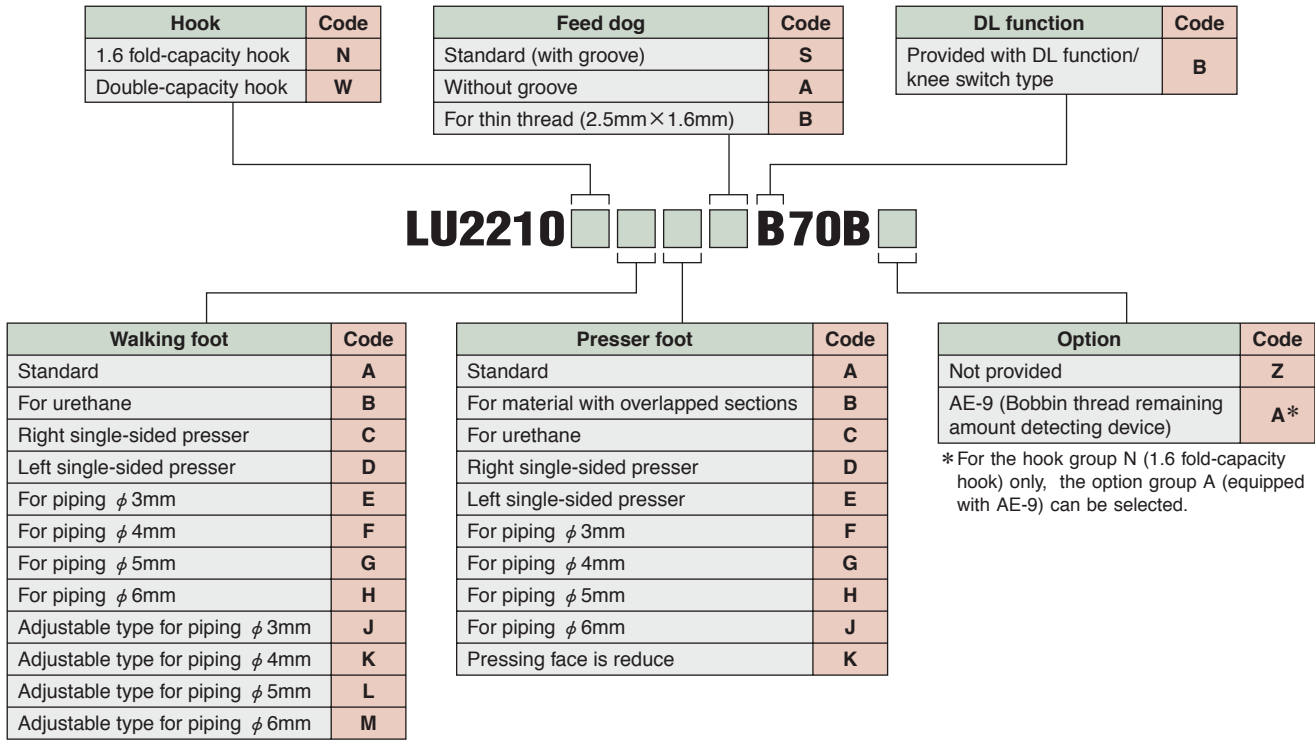

● To order, please contact your nearest JUKI distributor.

OPTIONS

● Bobbin thread remaining amount detecting device (optional): AE-9

Part No.		
AE-9 (kit C)	GAE09000CA0	for LU-2210N-7
AE-9 (kit D)	GAE09000DA0	for LU-2260N-7

The bobbin thread remaining-amount detecting device warns the operator with a buzzing sound and lamp indication of the time for bobbin thread replacement. This allows the operator to concentrate on sewing work without concern for the remaining amount of bobbin thread. Since the device directly detects the bobbin thread amount remaining, cumbersome setting is no longer required regardless of the material, thread and process.

● Suspended ruler: H152

Part No.	Description
MAH-152010A0	Suspended ruler (asm.)
SS-7151610SP×2	Screw
WP-0621016SD×2	Washer
WS-0610002KN×2	Spring washer

SPECIFICATIONS

Model name	LU-2210N-7	LU-2210W-7	LU-2260N-7	LU-2260W-7
	1-needle		2-needle	
Max. sewing speed	3,500rpm			
Max. stitch length	9mm (forward / backward)		6mm (forward / backward)	
Needle bar stroke	33.8mm			
Needle gauge (mm)	—		6, 8, 10 (standard), 12, 20*	
Lift of the presser foot	By hand: 9mm, By knee: 16mm (max)			
Auto lifter	Provided as standard (pneumatic auto-lifter: AK79)			
Thread take-up	Link type			
Alternating vertical movement	1~6.5mm			
Hook	Vertical-axis 1.6 fold-capacity hook	Vertical-axis double-capacity hook	Vertical-axis 1.6 fold-capacity hook	Vertical-axis double-capacity hook
Needle (at the time of delivery)	134×35 (Nm140) Nm100~Nm180		134×35 (Nm140) Nm100~Nm160	
Thread	#30~#4, B46~B138, Nm=60/3~20/3		#20~#5, B64~B138, Nm=40/3~20/3	
Safety mechanism	Provided as standard			
Lubrication	Automatic			
Lubricating oil	JUKI New Defrix Oil No.1 (equivalent to ISO VG7)			
Distance from needle to machine arm	264mm			
Bed size	517mm×178mm			
Weight of the machine head	55kg		58kg	
Automatic reverse feed function	Provided as standard			
Compressed air and air consumption	0.5MPa, 0.3dm ³ /min (ANR)			
Motor output	750W			
Power requirement	Single-phase 100~120V, 200~240V 3-phase 200~240V			
Power consumption	Rating 425VA			

* Configured for needle gauge width from 4mm to 36mm (LU-2260N-7) and 4mm to 30mm (LU-2260W-7).
Note that gauges not given above are also available on special order.



JUKI CORPORATION HEAD OFFICE
The environmental management system to promote and conduct
① the technological and technical research, the development and design of the products in which the environmental impact is considered,
② the conservation of the energy and resources, and the recycling, in the research, development, design, distribution, sale and maintenance service of the industrial sewing machines, household sewing machines and industrial-use robots, etc. and in the sale and maintenance service of the data entry system and in the purchase, distribution and sale of the household commodities including the healthcare products.

JUKI®

JUKI CORPORATION
MARKETING & SALES H.Q.

- * Specifications and appearance are subject to change without prior notice for improvement.
- * Read the instruction manual before putting the machine into service to ensure safety.
- * This catalogue prints with environment-friendly soyink on recycle paper.



www.lidermaq.com
ventas@lidermaq.net